

OMNI™ R²

1-1/2" and 2" OMNI R² Meter

Description

1-1/2" and 2" Sizes

The OMNI R² meter operation is based on advanced Floating Ball Technology (FBT).

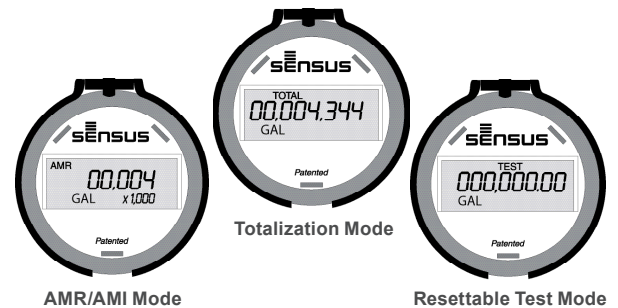

Features

CONFORMANCE TO STANDARDS

The OMNI R² meter meets and far exceeds the most recent revision of ANSI/AWWA Standard C701 class II standards and exceeds ANSI/AWWA C700 Residential Standard using Sensus Turbo technology. Each meter is performance tested to ensure compliance. All OMNI meters are NSF/ANSI Standard 61, Annex F and G approved.

PERFORMANCE

The patented measurement principles of the OMNI R² meter assure enhanced accuracy ranges, an overall greater accuracy, and a longer service life than any other comparable class meter produced. The OMNI R² meter has no restrictions as to sustained flow rates within its continuous operating range. The floating ball measurement technology allows for flows up to its rated maximum capacity without affecting undue wear or accuracy degradation when installed in any orientation.

CONSTRUCTION

The OMNI R² meter consists of two basic assemblies; the maincase and the measuring chamber. The measuring chamber assembly includes the "floating ball" impeller with a coated titanium shaft, hybrid axial bearings, integral flow straightener and an all electronic programmable register with protective bonnet. The maincase is made from industry proven Ductile Iron with an

approved NSF epoxy coating. Maincase features are; easily removable measuring chamber, unique chamber seal to the maincase using a high pressure o-ring, testing port and a convenient integral strainer.

OMNI ELECTRONIC REGISTER

The OMNI R² electronic register consist of a hermetically sealed register with an electronic pickup containing no mechanical gearing. The large character LCD displays AMR, Totalization and a Resettable Test Totalizer. OMNI register features; AMR resolution units that are fully programmable, Large, easy-to-read LCD also displays both forward and reverse flow directions and all with a 10-year battery life guarantee.

MAGNETIC DRIVE

Meter registration is achieved by utilizing a fully magnetic pickup system. This is accomplished by the magnetic actions of the embedded rotor magnets and the ultra sensitive register pickup probe. The only moving component in water is the "floating ball" impeller.

MEASURING ELEMENT

The revolutionary thermoplastic, hydro dynamically balanced impeller floats between the bearings. The Floating Ball Technology (FBT) allows the measuring element to operate virtually without friction or wear, thus creating the extended upper and lower flow ranges capable on only the OMNI R² meter.

STRAINER

The OMNI R² with the "V" shaped integral strainer using a stainless steel screen along with Floating Ball Technology (FBT) create a design that gives far improved accuracy even in those once thought questionable settings. A removable strainer cover permits easy access to the screen for routine maintenance.

MAINTENANCE

The OMNI R² meter is designed for easy maintenance. Should any maintenance be required, the measuring chamber and/or strainer cover can be removed independently. Parts and or a replacement measuring chamber may be utilized in the event repairs are needed. Replacement Measuring Chambers are available for the OMNI R² meters and may be utilized for retrofitting to competitive meters to achieve increased accuracy and extended service life.

AMR / AMI SYSTEMS

Meters and encoders are compatible with current Sensus AMR/AMI systems.

GUARANTEE

Sensus OMNI R² Meters are backed by "The Sensus Guarantee." Ask your Sensus representative for details or see Bulletin G-500.

OMNI R²: 1-1/2" and 2" Sizes

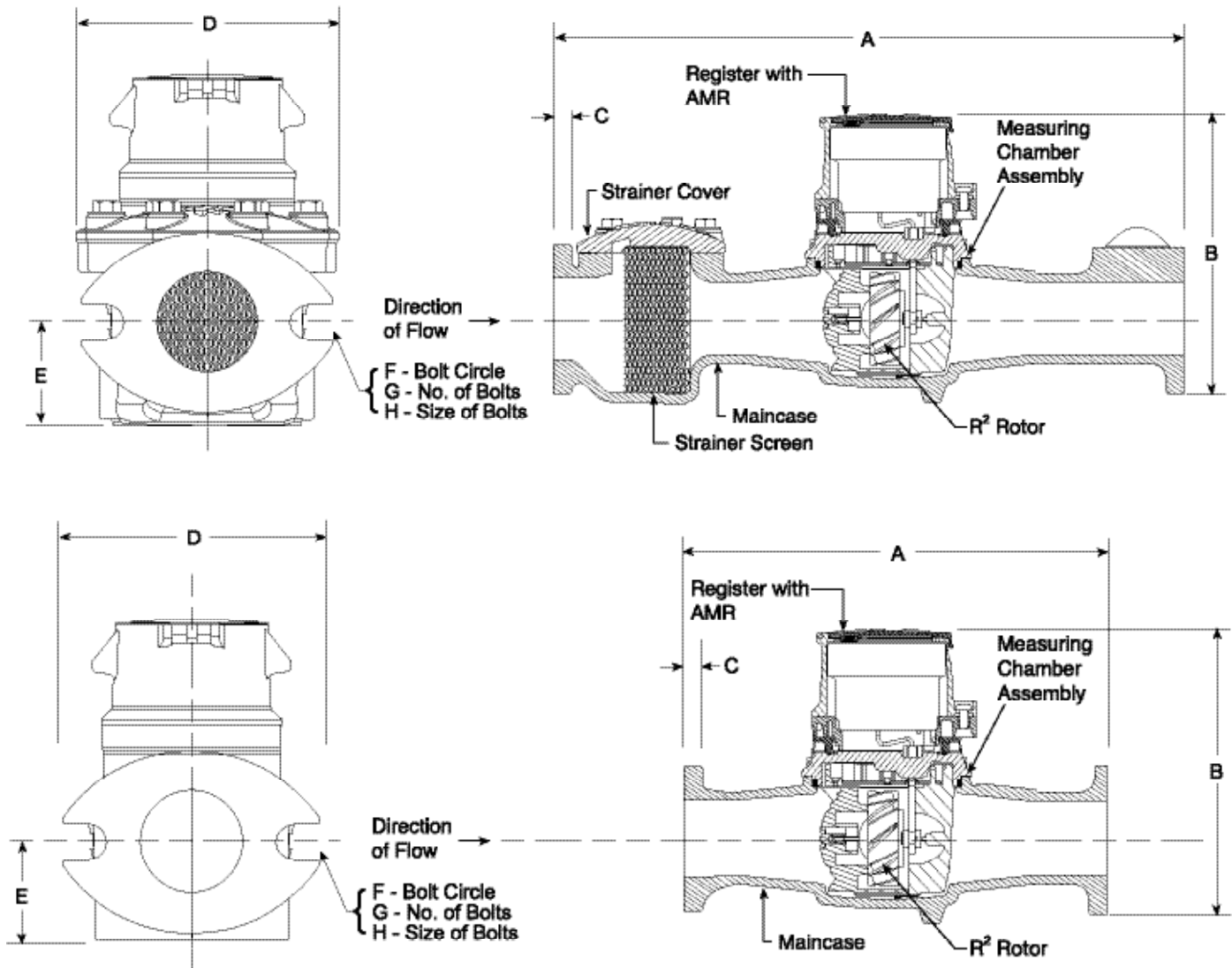

DIMENSIONS AND NET WEIGHTS

Meter and Pipe Size	Normal Operating Range		Connections	A	B	C	D	E	F	G	H	J	Net Weight	Shipping Weight
1-1/2" DN 40mm	2 gpm .45 m ³ /hr	150 gpm 34 m ³ /hr	Flanged	13" 330mm	7-7/8" 200mm	15/16" 24mm	5-1/8" 130mm	2-5/16" 59mm	4" 102mm	2	5/8" 16mm	1" 25mm	18.8 lbs. 8.53 kg.	22.5 lbs. 10.20 kg.
2" DN 50mm	2.5 gpm .56 m ³ /hr	200 gpm 45 m ³ /hr	Flanged	17" 432mm	7-7/8" 200mm	1" 25mm	5-3/4" 146mm	2-5/16" 59mm	4-1/2" 114mm	2	3/4" 19mm	1" 25mm	27.4 lbs. 12.42 kg.	34.5 lbs. 15.65 kg.
2" without Strainer DN 80mm	2.5 gpm .56 m ³ /hr	250 gpm 57 m ³ /hr	Flanged	10" 254mm	7-7/8" 200mm	1" 25mm	5-3/4" 146mm	2-5/16" 59mm	4-1/2" 114mm	2	3/4" 19mm	1" 25mm	17 lbs. 7.9 kg.	24.5 lbs. 11.11 kg.

OMNI R²: 1-1/2" and 2" Sizes

SPECIFICATIONS

SERVICE	Measurement of potable and reclaim water. Operating temperature range of 33 °F (.56 °C) - 150 °F (65.6 °C)
OPERATING RANGE (100% ± 1.5%)	1-1/2": 2 – 150 GPM (.45 - 34 m ³ /hr) 2": 2.5 – 200 GPM (.56 – 45 m ³ /hr) 2" without Strainer: 2.5 – 200 GPM (.56 – 45 m ³ /hr)
LOW FLOW (95% – 101.5%)	1-1/2": .75 GPM (.17 m ³ /hr) 2": 1.0 GPM (.23 m ³ /hr) 2" without Strainer: 1.0 GPM (.23 m ³ /hr)
PRESSURE LOSS	1-1/2": 6.7 psi @ 150 GPM (0.46 bar @ 34 m ³ /hr) 2": 7.0 psi @ 200 GPM (.48 bar @ 45 m ³ /hr)
MAXIMUM OPERATING PRESSURE	200 PSI (13.8 bar)

FLANGE CONNECTIONS	U.S. ANSI B16.1 / AWWA Class 125	
REGISTER	Fully electronic sealed register with programmable registration (Gal. /Cu.Ft./ Cu. Mtr. / Imp.Gal / Acre Ft.) Programmable AMR/AMI reading output Guaranteed 10 year battery life	
NSF APPROVED MATERIALS	Maincase:	Coated Ductile Iron
	Measuring Chamber:	Thermoplastic
	Rotor "Floating Ball":	Thermoplastic
	Radial Bearings:	Hybrid Thermoplastic
	Thrust Bearings:	Sapphire/Ceramic Jewel
	Magnets:	Ceramic Magnet
	Strainer Screen:	Stainless Steel
	Strainer Cover:	Coated Ductile Iron
	Test Plug:	Coated Ductile Iron

Headloss Curves

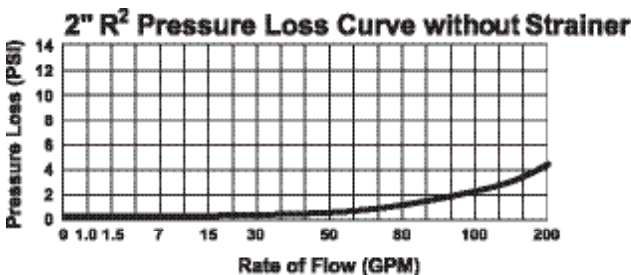
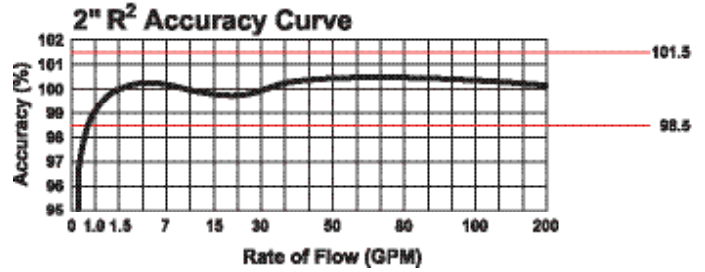
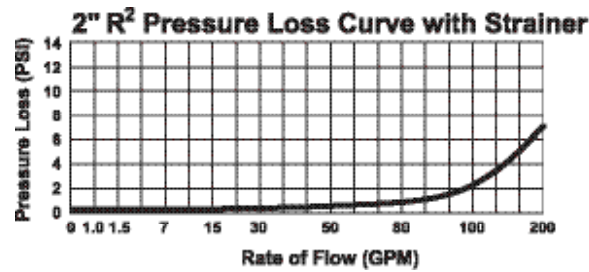
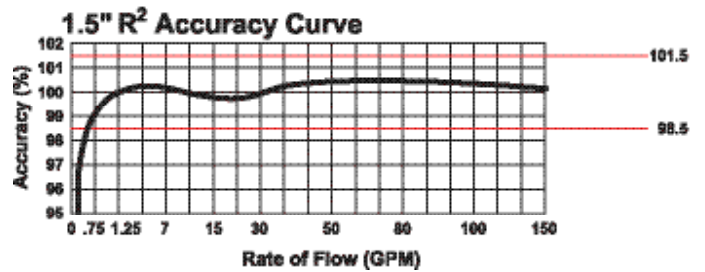
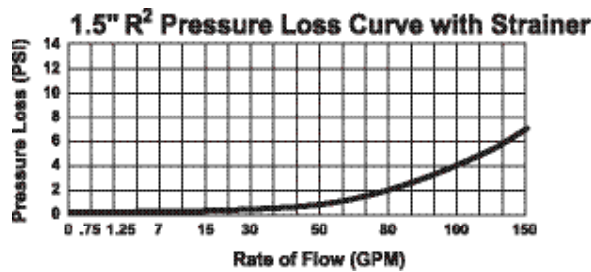

© All products purchased and services performed are subject to Sensus' terms of sale, available at either; <http://na.sensus.com/TC/TermsConditions.pdf> or 1-800-METER-IT. Sensus reserves the right to modify these terms and conditions in its own discretion without notice to the customer.

This document is for informational purposes only, and SENSUS MAKES NO EXPRESS WARRANTIES IN THIS DOCUMENT. FURTHERMORE, THERE ARE NO IMPLIED WARRANTIES, INCLUDING WITHOUT LIMITATION, WARRANTIES AS TO FITNESS FOR A PARTICULAR PURPOSE AND MERCHANTABILITY. ANY USE OF THE PRODUCTS THAT IS NOT SPECIFICALLY PERMITTED HEREIN IS PROHIBITED.